



METROLOGIC INSTRUMENTS, INC.
HoloTrak[®] IS8000 Series
Holographic Scanners
Installation and User's Guide



LOCATIONS

CORPORATE HEADQUARTERS NORTH AMERICA

USA, NEW JERSEY

Metrologic Instruments, Inc.
Tel: 1-800-ID-METRO Fax: 856-228-6673
Email: info@metrologic.com

SOUTH AMERICA, BRAZIL SÃO PAULO

Metrologic do Brasil Ltda.
Tel: 55-11-5182-8226 Fax: 55-11-5182-8315
Email: info@br.metrologic.com

SOUTH AMERICA, OUTSIDE BRAZIL SÃO PAULO

Metrologic South America
Tel: 55-11-5182-7273 Fax: 55-11-5182-7198
Email: info@sa.metrologic.com

ASIA, SINGAPORE

Metrologic Asia (Pte) Ltd
Tel: 65-6842-7155 Fax: 65-6842-7166
Email: info@sg.metrologic.com

CHINA, SUZHOU

Metro Technologies Co., Ltd.
Tel: 86-512-62572511 Fax: 86-512-62571517
Email: info@cn.metrologic.com

Metro Sales Office

Tel: 86-512-67622550 Fax: 86-512-67622560
Email: info@cn.metrologic.com

JAPAN, TOKYO

Metrologic Japan Co., Ltd.
Tel: 81-03-3839-8511 Fax: 81-03-3839-8519
Email: info@jp.metrologic.com

EUROPEAN, MIDDLE EAST & AFRICAN HEADQUARTERS

GERMANY, MUNICH

Metrologic Instruments GmbH
Tel: 49-89-89019-0 Fax: 49-89-89019-200
Email: info@europe.metrologic.com

GERMANY, MUNICH

Metrologic Instruments GmbH
Tel: 49-89-89019-0 Fax: 49-89-89019-200
Email: info@de.metrologic.com

ITALY, BOLOGNA

Metrologic Instruments Italia srl
Tel: +39 0 51 6511978 Fax: +39 0 51 6521337
Email: info@it.metrologic.com

FRANCE, PARIS

Metrologic Eria France SA
Tel: +33 (0) 1 48.63.78.78
Fax: +33 (0) 1 48.63.24.94
Email: info@fr.metrologic.com

SPAIN, MADRID

Metrologic Eria Ibérica, SL
Tel: +34 913 272 400 Fax: +34 913 273 829
Email: info@es.metrologic.com

Metrologic Europe Repair Center (MERC)

Metrologic Eria Ibérica, SL
Tel: +34 913 751 249 Fax: +34 913 270 437

UNITED KINGDOM, BASINGSTOKE

Metrologic Instruments UK Limited
Tel: +44 (0) 1256 365900
Fax: +44 (0) 1256 365955
Email: info@uk.metrologic.com

RUSSIA, MOSCOW

Metrologic Russia
Tel: +7 095 730 7424 Fax: +7 095 730 7425
Email: info@ru.metrologic.com

Copyright

© 2004 by Metrologic Instruments, Inc. All rights reserved. No part of this work may be reproduced, transmitted, or stored in any form or by any means without prior written consent, except by reviewer, who may quote brief passages in a review, or provided for in the Copyright Act of 1976.

Products and brand names mentioned in this document are trademarks of their respective companies.

TABLE OF CONTENTS

Introduction.....	1
Scanner and Accessories.....	2
Installing the Scanner to the Host (Standard Features)	
Single Holotrak® Installation.....	3
Holotrak® Primary/Secondary Installation	3
Installing the Scanner to the Host (Optional Features)	
Industrial Controller MX001 Interface Option	5
External Speaker Box Option	6
Hand-held Port Option	7
Configuration to the Host System.....	8
Installing and Running the MetroSet®2 Program	8
Parts of the Scanner.....	10
Mounting Bracket Installation	11
Visual and Audible Indicators	12
Labels.....	13
Depth of Field and Scan Pattern Characteristics	
IS8300 Depth of Field and Scan Pattern	14
IS8400 Depth of Field and Scan Pattern	15
IS8500 Depth of Field and Scan Pattern	16
IS8800 Depth of Field and Scan Pattern	17
Maintenance.....	18
Trouble Shooting Guide.....	19
Appendix A	
Design Specification	20
Appendix B	
Default Settings	22
Appendix C	
IS8000 Series Pinout Connections	27
Appendix D	
Limited Warranty.....	29
Appendix E	
Notices.....	30
Appendix F	
Patents	32
Index.....	33

INTRODUCTION

Metrologic's IS8000 series scanners bring the benefits of holography to long-range industrial bar code scanning. Enclosed in rugged NEMA-12 cases for industrial environments, the IS8000 series provides omnidirectional scanning with optional no code/wrong code warning. They can be mounted in any orientation and are capable of primary/secondary setup for added versatility.

There are several IS8000 models to choose from depending on the scanning application.

- The **IS8300** produces 5,250 scan lines per second with a depth of field of 457.2 mm (18")** and a width covering 304.8 mm (12")**
- The **IS8400** produces 3,360 scan lines per second with a depth of field of 711.2 mm (28")* and a width covering 558.8 (22")*
- The **IS8500** produces 5,600 scan lines per second with a depth of field of 711.2 mm (28")* and a width covering 558.8 (22")*
- The **IS8800** produces 5,600 scan lines per second with a depth of field of 812.8 mm (32")* and a width covering 457.2 (18")*

* The area defined is based conservatively on a 0.33 mm/0.013" bar code width. Actual scan areas will vary by label size and application.

** The area defined is based conservatively on a 0.25 mm/0.010" bar code width. Actual scan areas will vary by label size and application.

Several optional features are also available for the IS8000 series including a hand-held scanner port, Triac output, a high volume external speaker box and object sensor input with the use of a MX001 industrial control interface. All scanners can be programmed using Metrologic's MetroSet® configuration program available on CD or downloadable from Metrologic's web site at www.metrologic.com.

Applications and Protocols

The following chart specifies the version identifier for the communication protocol.

Scanner	Version Identifier	Communication Protocol(s)
IS8300 or IS8800	1	RS-232/RS-422/Light Pen Emulation
	1L	RS-232/RS-422/Light Pen Emulation Low Speed Option
IS8400 or IS8500	1	RS-232/RS-422/Light Pen Emulation
	1E	RS-232/RS-422/Light Pen Emulation with External Speaker
	1L	RS-232/RS-422/Light Pen Emulation Low Speed Option
	1LE	RS-232/RS-422/Light Pen Emulation Low Speed Option with External Speaker

SCANNER AND ACCESSORIES

The following is a list of parts included in a standard IS8000 kit:

- IS8000 Series HoloTrak[®] Holographic Scanner
- Power Supply
 - [MLPN 46-46207-US] 12VDC @ 4.16 Amps, 220VAC or
 - [MLPN 46-46207-UK] 12VDC @ 4.16 Amps, 240VAC or
 - [MLPN 46-46207-EC] 12VDC @ 4.16 Amps, 120VAC
- Communication Cable
 - [MLPN 52-52702] Standard 2 meter (6 ft.) cable
- Mounting Bracket
 - [MLPN 45-45615] for IS8300 or
 - [MLPN 45-45616] for IS8400/IS8500/IS8800
- Installation and User's Guide [MLPN 00-02377]
- MetroSet[®] Scanner Configuration Software for Windows

Optional Accessories available:

- [MLPN MX008] MX008 External Speaker (for use with IS8400 & IS8500 only)
 - MX008 High Volume Speaker
 - [MLPN 52-52206] 3.7 meter (12 ft.) Communication Cable
- [MLPN 45-45745] MX001 for Single Scanner Setup
 - MX001 Industrial Controller
 - [MLPN 52-52708] Communication Cable
- [MLPN 45-45718] MX001 for Primary/Secondary Scanner Setup
 - [MLPN 45-45745] MX001 for Single Scanner Setup
 - [MLPN 52-52709] Communication "Y" Cable
- Cables
 - [MLPN 52-52704] 6 meter (20 ft.) IS8000 Series Communication Cable
 - [MLPN 52-52707] 3 meter (10 ft.) IS8000 Secondary Cable (not for use with MX001)
 - [MLPN 51-51882] 0.25 meter (10 inch) Tech Secondary Adapter Cable
- Replacement Parts
 - [MLPN 45-45224] Scan Window for IS8300
 - [MLPN 45-45223] Scan Window for IS8400/IS8500/IS8800

If any item is missing or to order additional items, contact the dealer, distributor or call Metrologic's Customer Service Department at 1-800-ID-METRO or 1-800-436-3876.

INSTALLING THE SCANNER TO THE HOST (STANDARD FEATURES)

Single HoloTrak® Installation



To avoid potential problems, do not power up the scanner until the communication cable is secured to the host.

1. Turn off the host system.
2. Connect the communications cable to the HoloTrak® and to the host.
3. Check the AC input requirements of the power supply to make sure the voltage matches the AC outlet.
4. Plug the power supply to the scanner.
5. Plug the power supply into the AC outlet to supply power to the scanner.
6. Power up the host system.

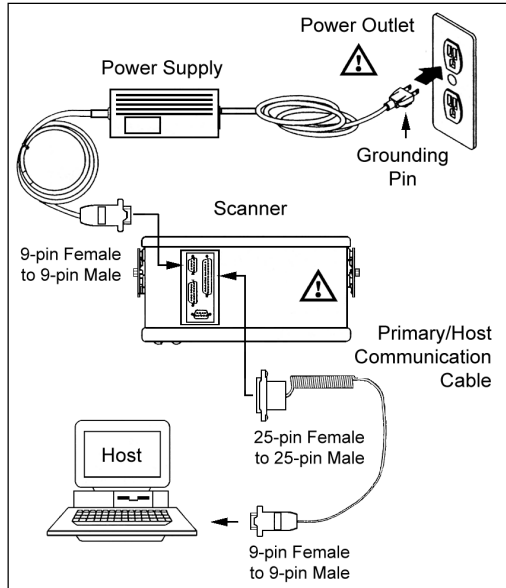

HoloTrak Primary/Secondary Feature

The primary/secondary feature gives the ability to connect or "daisy-chain" two scanners together to act as one scanner interfacing with only one host.

PRIMARY/SECONDARY COVERAGE WITH ONE HOST AND TWO HOLOTRAKS

	Single Conveyor	Two Conveyors
IS8300	12" (305 mm) to 24" (610 mm)	12" (305 mm) coverage per conveyor
IS8400	22" (559 mm) to 44" (1118 mm)	22" (559 mm) coverage per conveyor
IS8500	22" (559 mm) to 44" (1118 mm)	22" (559 mm) coverage per conveyor
IS8800	18" (457 mm) to 36" (914 mm)	18" (457 mm) coverage per conveyor

Continued on next page



Caution:

To maintain compliance with applicable standards, all circuits connected to the scanner must meet the requirements for SELV (Safety Extra Low Voltage) according to EN 60950.

To maintain compliance with standard CSA C22.2 No. 950/UL 1950 and norm EN 60950, the power source should meet applicable performance requirements for a limited power source.

INSTALLING THE SCANNER TO THE HOST (STANDARD FEATURES)

Primary/Secondary setup continued from previous page.

All equipment must be connected before power-up. After both units complete the power-up diagnostics, the operator will need to program the primary unit with the MetroSet Program provided.

Additional Equipment needed: Primary/Secondary Cable [MLPN 52-52707]



To avoid potential problems, do not power up the scanner until the communication cable is secured to the host.

1. Turn off the host system.
2. Connect the communications cable to the HoloTrak® primary scanner and to the host.
3. Connect the Primary/Secondary cable to the primary scanner and the secondary scanner.
4. Check the AC input requirements of the power supplies for both scanners to make sure the voltages match the AC outlets.
5. Connect the power supplies to the scanners.
6. Plug the power supplies into the AC outlets to supply power to the both scanners.
7. Power up the host system.

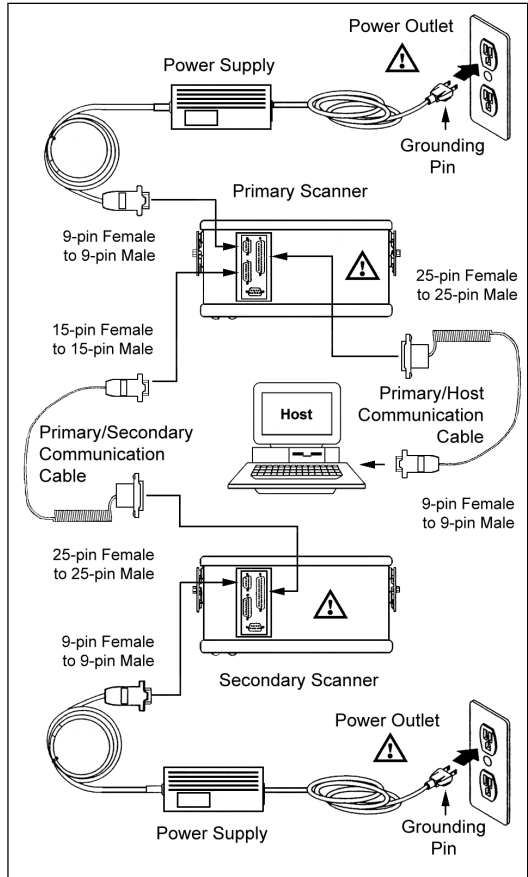

Caution:

To maintain compliance with applicable standards, all circuits connected to the scanner must meet the requirements for SELV (Safety Extra Low Voltage) according to EN 60950.

To maintain compliance with standard CSA C22.2 No. 950/UL 1950 and norm EN 60950, the power source should meet applicable performance requirements for a limited power source.

INSTALLING THE SCANNER TO THE HOST (OPTIONAL FEATURES)

Industrial Controller MX001 Interface Option

The MX001 Industrial Control Interface performs three functions.

- Through an object sensor input, the scanner can be alerted to any package present in the scan field. The sensor must have a 12V or 5V at 10mA output signal or switch closure (relay) output. The MX001 can also supply 12VDC power at 200mA (max) to the sensor. (*MetroSet 2 configuration required*)
- The MX001 electronic switch or *Triac*, allows the scanner to control an external device directly by switching on and off a 115 VAC at 10 Amps or 230VAC at 6 Amps output signal. (*MetroSet 2 configuration required*)
- It can alert the user that sensor conditions are not nominal (Sensor Alarm).



Special configuration of the MX001 Industrial controller is necessary for proper installation. Please refer to the MX001 Industrial Control Interface Installation and User's Guide [MLPN 00-02173] and the MetroSet 2 documentation for complete details.



To avoid potential problems, do not power up the scanner until the communication cable is secured to the host.



Only one MX001 can be used in the primary/secondary setting (*not shown*), and it **MUST** be connected to the primary scanner.

1. Turn off the host system.
2. Connect the communications cable to the HoloTrak[®] and to the host.
3. Connect the External MX001/Triac cable to the HoloTrak and the MX001.
4. Check the AC input requirements of the power supply for the scanner to make sure the voltage matches the AC outlet.
5. Connect the power supply to the HoloTrak.
6. Plug the power supply into the AC outlet.
7. Power up the host system.

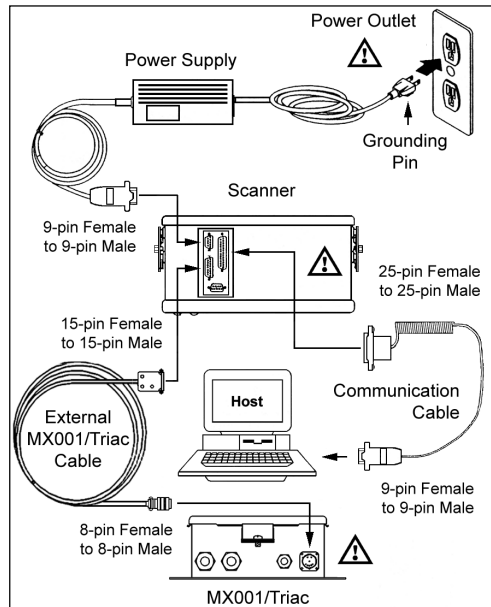

Refer to caution statement on page 4.

INSTALLING THE SCANNER TO THE HOST (OPTIONAL FEATURES)

External Speaker Box Option

When attached, beeper tones from the scanner are emitted from both the scanner speaker and external speaker to serve as an audible indication of the operation of the scanner.

There are 6 beeper options available:

- Normal Tone
- Tone 1
- Tone 2
- Tone 3
- Tone 4
- No Tone

Beeper tones can be adjusted by using the MetroSet[®] program.



To avoid potential problems, do not power up the scanner until the communication cable is secured to the host.

1. Turn off the host system.
2. Connect the communications cable to the HoloTrak[®] and to the host.
3. Connect the External MX008 cable to the HoloTrak and the MX008.
4. Check the AC input requirements of the power supply for the scanner and the MX008 to make sure the voltages match the AC outlets.
5. Connect the power supply to the HoloTrak.
6. Plug the power supplies into the AC outlet.
7. Power up the host system

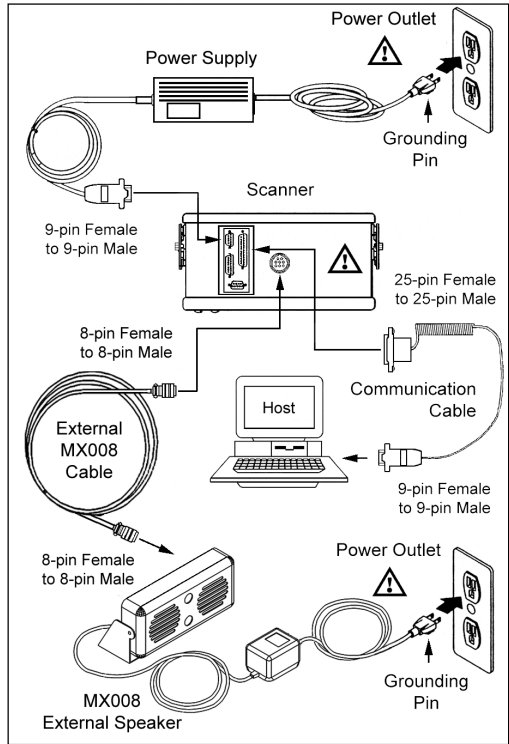

Caution:

To maintain compliance with applicable standards, all circuits connected to the scanner must meet the requirements for SELV (Safety Extra Low Voltage) according to EN 60950.

To maintain compliance with standard CSA C22.2 No. 950/UL 1950 and norm EN 60950, the power source should meet applicable performance requirements for a limited power source.

INSTALLING THE SCANNER TO THE HOST (OPTIONAL FEATURES)

Hand-held Port Option

A Non-Decode Hand-Held Scanner can be connected to an IS8000 series fixed scanner.



To avoid potential problems, do not power up the scanner until the communication cable is secured to the host.

1. Turn off the host system.
2. Connect the communications cable to the HoloTrak[®] and to the host.
3. Connect the communication cable of the hand-held scanner to the HoloTrak.
4. Check the AC input requirements of the power supply for the scanner to make sure the voltage matches the AC outlet.
5. Connect the power supply to the HoloTrak.
6. Plug the power supply into the AC outlet.
7. Power up the host system.

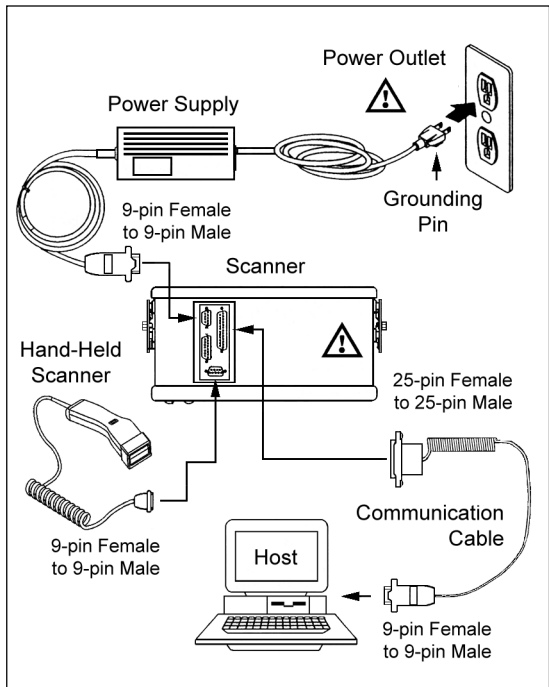

When the hand-held scanner first receives power, it will immediately go through a self-diagnostic routine, then the green and red LEDs will flash, and the unit will beep once.



Caution:

To maintain compliance with applicable standards, all circuits connected to the scanner must meet the requirements for SELV (Safety Extra Low Voltage) according to EN 60950.

To maintain compliance with standard CSA C22.2 No. 950/UL 1950 and norm EN 60950, the power source should meet applicable performance requirements for a limited power source.

CONFIGURATION TO THE HOST SYSTEM

The scanner is shipped from the factory configured to a set of default conditions noted in the *Default Settings* section of this guide. In order for the scanner to communicate with the host system, it will need to be properly configured. Since each host system is unique, the scanner must be configured to match the host system requirements. Use the MetroSet[®]2 Scanner Configuration Program provided to configure the scanner.

Primary/Secondary Configuration Note

During configuration, the secondary scanner's communication protocol will be established automatically through the primary scanner. If the configuration is to be downloaded from the host to the scanners, it is required that both the primary and the secondary scanners are powered up and ready to scan. The appropriate communications cables should be connected between the host and the primary scanner and between the primary and the secondary scanner.

Once a configuration is downloaded to the primary scanner, the primary will automatically configure the HoloTrak secondary scanner. This step is necessary in order to configure the secondary scanner properly. For all practical purposes, the scanners will act as one scanner. Once both units are configured, the scanner settings are stored in non-volatile RAM, and will not need to be configured again.

INSTALLING AND RUNNING THE METROSET[®] 2 PROGRAM

Installation

1. Close all open applications.
2. Insert the MetroSet[®] 2 CD into your CD drive.
3. The installation wizard will display the *Welcome* dialog box, select **N**ext to proceed to with the installation.



If the wizard does not automatically start, go to the windows **S**tart menu, choose **R**un, designate the CD-ROM drive, type **s**etup (d:\setup) and then click OK.

4. To accept the default installation directory, select **N**ext. To change the destination folder, select **B**rowse to locate and choose the desired folder.
5. To accept the default program folder, select **N**ext. To change the default program folder type a new folder name or choose an existing folder.
6. When the setup process is complete, select **Y**es, and choose **F**inish to restart your computer.

INSTALLING AND RUNNING THE METROSET® 2 PROGRAM

How to Start



To avoid potential problems, do not power up the scanner until the communication cable is secured to the host.

1. Turn **off** the PC after installing the MetroSet 2 program.
2. Connect the communication cable to the scanner and to the RS-232C serial port (COM1 or COM2) located on the PC.
3. Check the AC input requirements of the transformer to make sure the voltage matches the AC outlet. An easily accessible socket-outlet should be installed near the equipment.
4. Power up the scanner.
5. Turn on the PC.
6. From your Start menu choose **P**rograms, **M**etroSet 2, **M**etroSet 2.
7. Select **H**olotrak® as the unit to configure.
8. Then choose **C**onfigure.
9. For detailed instructions on the configuration options available choose Help from the menu bar.



Metrologic's HoloSet® program can also be used to configure the scanner.



Caution:

To maintain compliance with applicable standards, all circuits connected to the scanner must meet the requirements for SELV (Safety Extra Low Voltage) according to EN 60950.

To maintain compliance with standard CSA C22.2 No. 950/UL 1950 and norm EN 60950, the power source should meet applicable performance requirements for a limited power source.

PARTS OF THE SCANNER

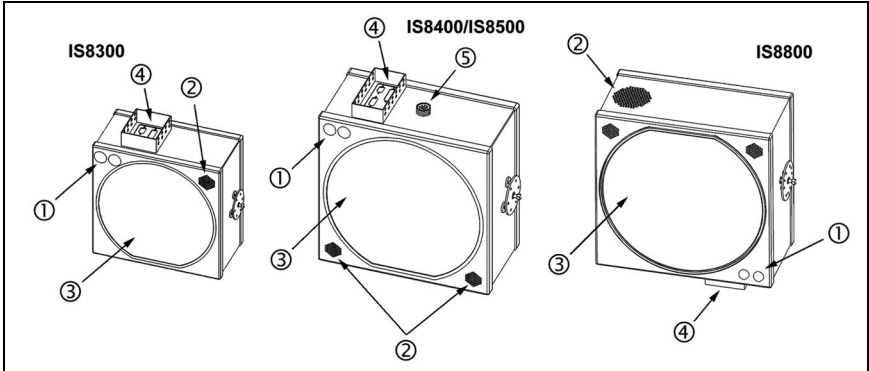

① Green and Red LEDs

The red LED is on when the unit is done power up, the VLD is emitting light and the unit is ready to scan. The green LED flashes when the scanner has read a bar code successfully. The functions of the LED's can be reversed through special configuration with the MetroSet[®] 2 configuration program. See the *Visual and Audible Indicators* section of this guide for more details.

② Speaker

The speaker is configured to emit a beep when a bar code has been transmitted. The IS8800 has an additional 90 dB speaker location on the side of the case.

③ Laser Output Window

This aperture emits and receives laser light.

④ D-type Connector Area

This area contains four D-type male connectors, a 25-pin, 15-pin, and two 9-pin D-sub connectors. The 25-pin connector is designed to attach a communication cable to the host device. The 15-pin connector is used to attach two scanners as primary/secondary and/or to connect the MX001 industrial control interface to the scanner. The first 9-pin connector is used to attach the power supply to the scanner and the second 9-pin connector is used to attach a hand held 5V non-decode type scanner to the HoloTrak[®]. Refer to *Appendix C* for Pinout details.

⑤ D-type Connector Area

The 8-pin Male AMP Connector is used to attach the optional MX008 external speaker box. Refer to *Appendix C* for Pinout details

MOUNTING BRACKET INSTALLATION

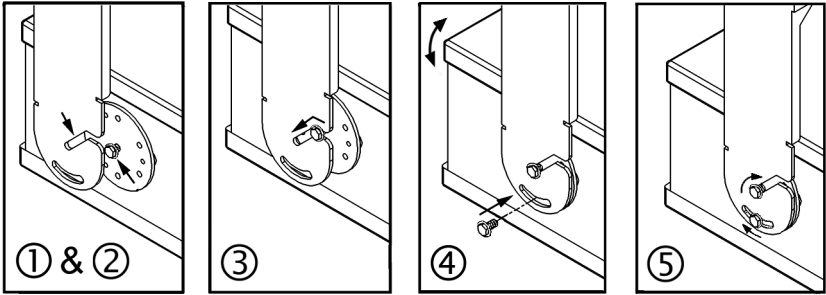

1. Locate the mounting bolts on the sides of the scanner.
2. Align the bolts on the scanner with the channels on the mounting bracket.
3. Slide the unit into place until the scanner bolts sit securely in the bottom of the channels.
4. Rotate the unit to the desired angle and secure into place with a locking bolt in the lower slot.
5. Tighten both bolts to secure the scanner in place.

Mounting Bracket Hole Pattern

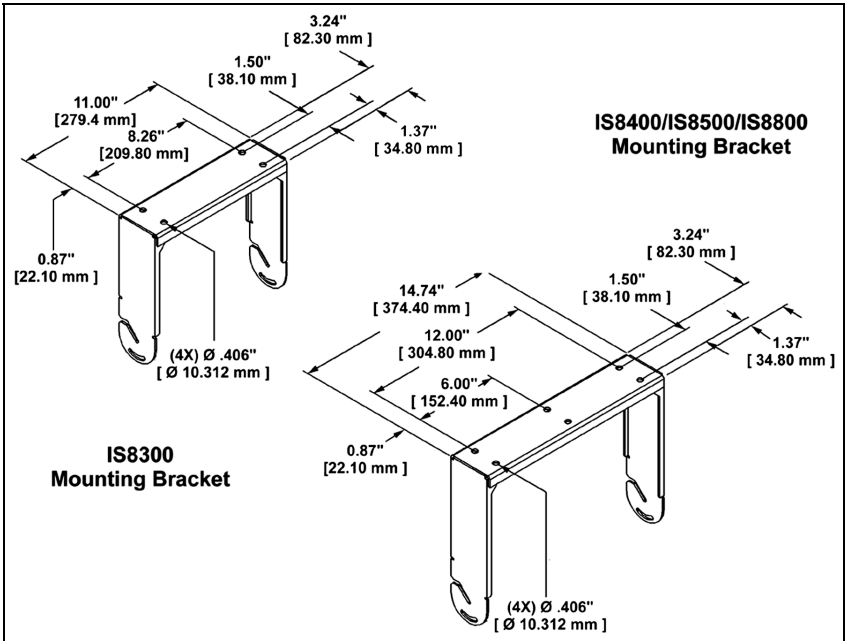

VISUAL AND AUDIBLE INDICATORS

When the scanner is on, the activity of the red and green LEDs indicate the status of the scanner.

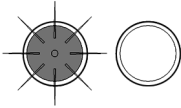
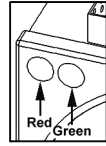

Flashing Red, No Green

During power-up and diagnostic mode.



Steady Red, No Green

Unit has completed power-up, the VLD is emitting light, and the unit is ready to scan.

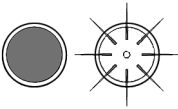

Steady Red, Green Flash

When the scanner transmits a successful read, the green LED will flash. Generally, if the green LED does not flash, then the bar code has not been successfully read. If handshaking is being used, the green LED goes out when proper handshaking has completed. When the green light turns off, communication to the host is complete.

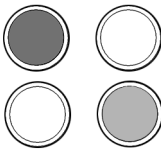

Alternating Red and Green with razz tone

This indicates a motor failure.

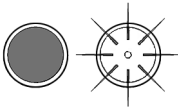

Steady Red, Green Flashing with a beep

Scanner has entered program mode successfully. (See *Running the MetroSet[®] 2 Program* for more details on configuring the scanner).

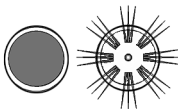
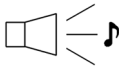

Steady Red, Green Flashes 3 times with 3 beeps

Scanner has exited program mode successfully.

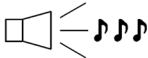

Note: If the scanner has been configured for reverse LED convention, via MetroSet 2, all mode indicators described above also reverse.

LABELS

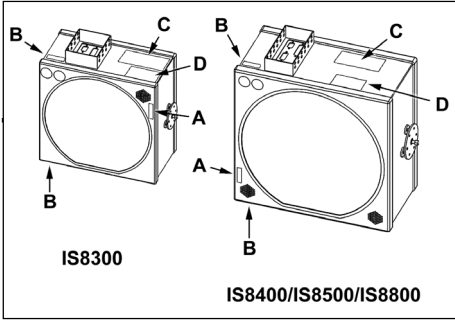

A

AVOID EXPOSURE
Laser light is emitted
from this aperture.

B

Danger - Laser light when open
AVOID DIRECT EXPOSURE TO BEAM

C

HoloTrak®
by Metrologic instruments, Inc.
Blackwood, New Jersey, USA



Contains no user servicable components.
Warranty void if case is opened.
Complies with FCC Class A. See manual.

Manufactured Blackwood, NJ.
June 2000 (D) 12V ^{DC}

Model: **IS8XXX RS232/RS422**
Barcode Scanner
Serial #: 0000000000

SAMPLE

This product complies with US
DHHS Standard 21 CFR Chapter 1
Subchapter J.

See User's Guide for patent coverage.

D

ACHTUNG LASERSTRAHL. LASERCLASSE 2.
NICHT IN DEN STRAHL BLICKEN.
LUMIERE LASER - NE PAS REGARDER DANS
LE FAISCEAU APPEREIL A LASER DE CLASSE 2.
CAUTION - LASER LIGHT: DO NOT STARE INTO BEAM
CLASS 2 LASER PRODUCT
OUTPUT POWER = 7.7 MILLIWATT (PEAK) < 1 mW AVG. POWER.
VLD WAVELENGTH = 630 - 690 nm; EN60825-1:1994/A11 : 1996



CAUTION



LASER LIGHT
DO NOT STARE
INTO BEAM

7.7 MILLIWATT (PEAK) < 1 mW AVG. POWER
VLD WAVELENGTH = 630-690 nm
CLASS II LASER PRODUCT

Complies with
21 CFR Chapter 1
subchapter J.

Meets Part 15
of FCC rules.
See manual.

DEPTH OF FIELD AND SCAN PATTERN CHARACTERISTICS

IS8300 Depth of Field and Scan Pattern

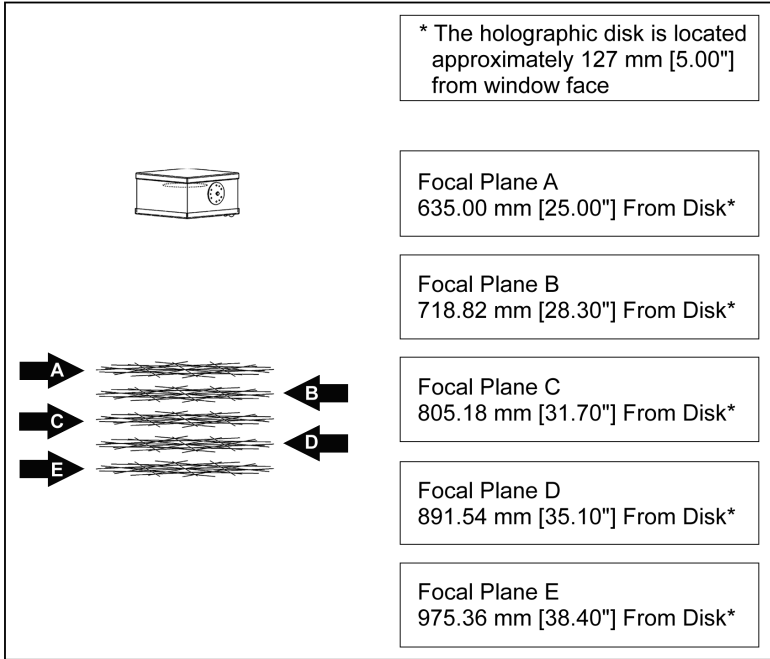

The depth of field area defined is based conservatively on a 0.25 mm/0.010" bar code width. Actual scan areas will vary by label size and application.

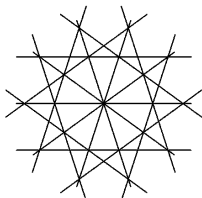

Scan Pattern of a Single Focal Plane

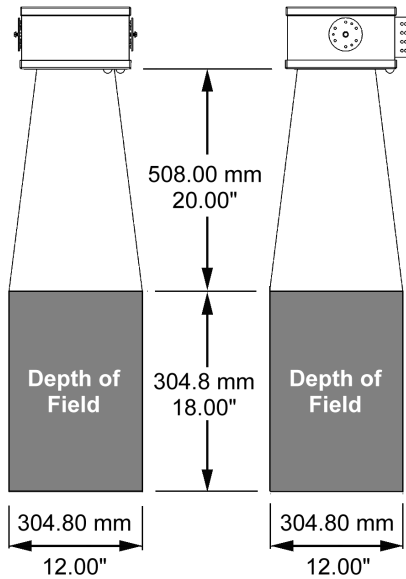

DEPTH OF FIELD AND SCAN PATTERN CHARACTERISTICS

IS8400 Depth of Field and Scan Pattern

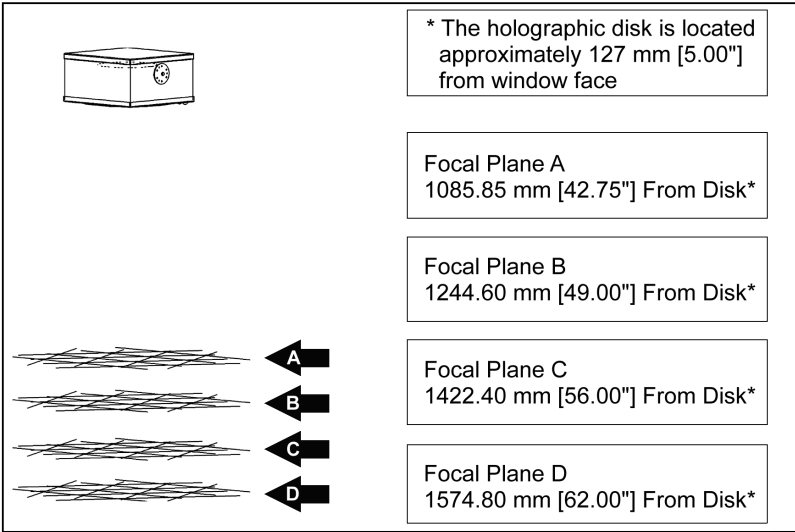

The depth of field area defined is based conservatively on a 0.33 mm/0.013" bar code width. Actual scan areas will vary by label size and application.

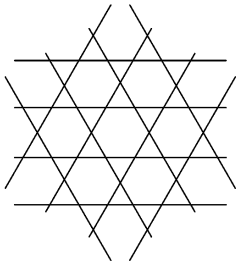

Scan Pattern of a Single Focal Plane

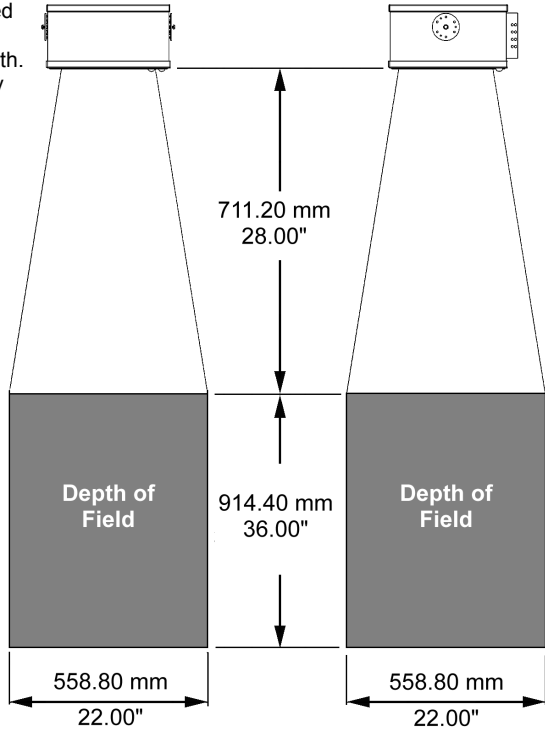

DEPTH OF FIELD AND SCAN PATTERN CHARACTERISTICS

IS8500 Depth of Field and Scan Pattern

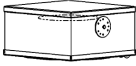

* The holographic disk is located approximately 127 mm [5.00"] from window face

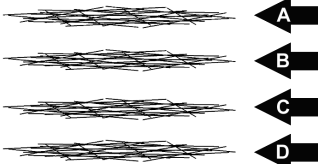

Focal Plane A
1085.85 mm [42.75"] From Disk*

Focal Plane B
1244.60 mm [49.00"] From Disk*

Focal Plane C
1422.40 mm [56.00"] From Disk*

Focal Plane D
1574.80 mm [62.00"] From Disk*

The depth of field area defined is based conservatively on a 0.33 mm/0.013" bar code width. Actual scan areas will vary by label size and application.

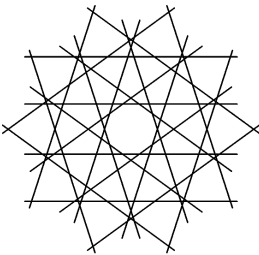

Scan Pattern of a Single Focal Plane

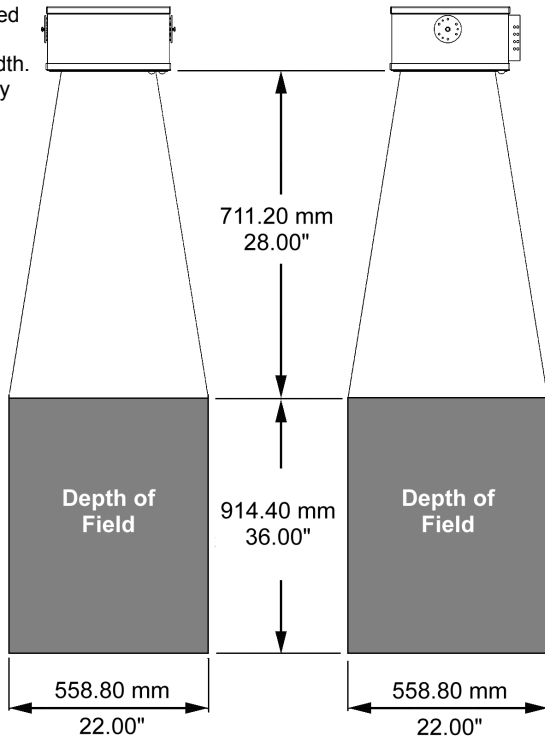

DEPTH OF FIELD AND SCAN PATTERN CHARACTERISTICS

IS8800 Depth of Field and Scan Pattern

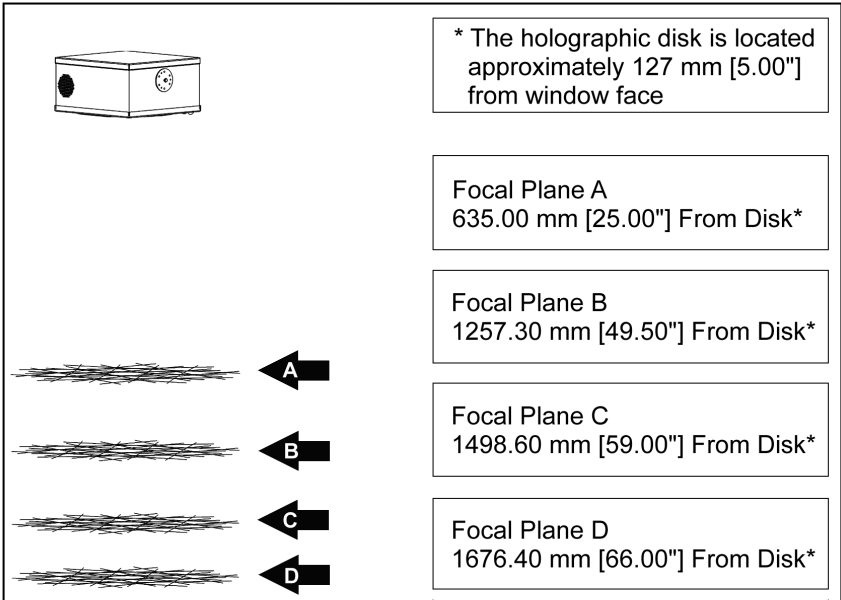

The depth of field area defined is based conservatively on a 0.33 mm/0.013" bar code width. Actual scan areas will vary by label size and application.

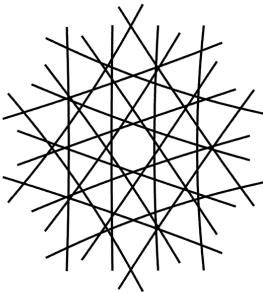

Scan Pattern of a Single Focal Plane

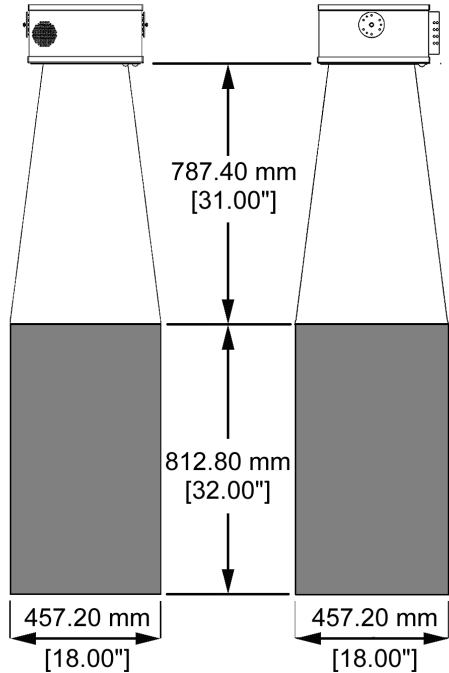

MAINTENANCE

Smudges and dirt can interfere with the proper scanning of a bar code. Therefore, the output window will need occasional cleaning.

1. Spray optical quality cleaning fluid onto lint free, nonabrasive cleaning cloth.
2. Gently wipe the output window.



Do not use solvents like alcohol or acetone. These materials can damage the window.

TROUBLESHOOTING GUIDE

PROBLEM	POSSIBLE CAUSE(S)	ACTION NEEDED
No LEDs	No Power	Check the power supply and outlet.
No Scan Pattern	No Power	
Alternating Red and Green LEDs flash with a razz tone.	Motor Failure	Contact a Metrologic service representative.
The unit scans but does not communicate with the host.	The communication cable is not connected to the COM port.	Check the communication cable connection at the host and scanner.
	The communication cable is damaged.	Replace the communication cable.
	Scanner configuration settings have been lost.	Reconfigure using MetroSet 2.
The host is receiving data but the data does not look correct.	There is an interface format incompatibility.	Check that the unit and the host are configured for the same interface format.
Unit has shows a reduction in scan performance.	Scan window dirty	Clean the unit's window (refer to the maintenance section).

APPENDIX A

Design Specifications

	IS8800	IS8500	IS8400	IS8300
Optical				
Number of VLD	5	5	3	5
Scan pattern	Omni	Omni	Omni	Omni
Scan lines per second	5,600	5,600	3,360	5,250
Focal planes	4	4	4	5
Scan lines per focal plane	20	20	12	15
Total scan lines	80	80	48	75
Minimum bar width	0.30 mm/0.012"	0.25 mm/0.010"	0.25 mm/0.010"	0.20 mm/0.008"
Scan Area (Small Bar Widths)				
Bar width	0.33 mm/0.013"	0.33 mm/0.013"	0.33 mm/0.013"	0.25 mm/0.010"
Near scan	790 mm/31"	910 mm/36"	910 mm/36"	510 mm/20"
Far scan	1600 mm/63"	1630 mm/64"	1630 mm/64"	970 mm/38"
Depth of field	810 mm/32"	720 mm/28"	720 mm/28"	460 mm/18"
Width	460 mm/18"	560 mm/22"	560 mm/22"	310 mm/12"
Conveyor speed	1.5 mps/300 fpm	1.5 mps/300 fpm	1.5 mps/300 fpm	1.5 mps/300 fpm
Mechanical				
Length	349 mm/13.75"	349 mm/13.75"	349 mm/13.75"	254 mm/10"
Width	336 mm/13.25"	336 mm/13.25"	336 mm/13.25"	380 mm/11.1"
Height	177 mm/7.0"	177 mm/7.0"	177 mm/7.0"	141 mm/5.5"
Weight	11.0 kg/25lb	11.0 kg/25lb	11.0 kg/25lb	9.0 kg/20lb
Case	NEMA 12	NEMA 12	NEMA 12	NEMA 12
Mounts any orientation	Yes	Yes	Yes	Yes
Interfaces				
Serial: RS-232C	RS232C	RS232C	RS232C	RS232C
Serial: Point-to-Point RS422	RS422	RS422	RS422	RS422
Light Pen Emulation	Light Pen	Light Pen	Light Pen	Light Pen
Handheld Scanner Port	Option	Option	Option	Option
Master slave	Yes	Yes	Yes	Yes
Industrial Controller/Triac	Yes	Yes	Yes	Yes

APPENDIX A (CONTINUED)

Design Specifications

	IS8800	IS8500	IS8400	IS8300
Electrical				
Input Voltage	12 VDC	12 VDC	12 VDC	12 VDC
Starting Power	69 watts	69 watts	53 watts	53 watts
Operating power	43 watts	43 watts	34 watts	34 watts
EMC: FCC, ICES-003 & EN 55022	Class A	Class A	Class A	Class A
Laser				
Wavelength	658 nm ± 5 nm	658 nm ± 5 nm	658 nm ± 5 nm	658 nm ± 5 nm
Laser power (peak)	7.7 mW	7.7 mW	7.7 mW	7.7 mW
Laser power (average)	<1 mW	<1 mW	<1 mW	<1 mW
Laser class: CDRH	Class II	Class II	Class II	Class II
Laser class: EN	Class 2	Class 2	Class 2	Class 2
Environmental				
Operating Temperature	0°C to 40°C (32°F to 104°F)			
Storage Temperature	-40°C to 60°C (-40°F to 140°F)			
Humidity	5% to 95% relative humidity, non-condensing			
Light Levels	Up to 297.4 lux (3200 foot candles) – works in direct sunlight			
Shock	100 g for 1 ms			
Contaminants	Protects against dust, falling dirt, and dripping non-corrosive liquid			
Ventilation	None required			
Actual scan areas will vary by label size and application.				
Specifications subject to change without notice.				

APPENDIX B

Default Settings

Many functions of the scanner can be configured, or enabled/disabled. The factory programs the scanner to a set of default parameters. These defaults are marked with an asterisk (*) in the default column on the following pages. Unmarked parameters show the unavailability for that protocol. To speak with the host system properly, the scanner must be configured to match the systems individual requirements. Not all functions support all communication protocols. If the protocol supports a function, a check mark appears on the chart.

PARAMETER	DEFAULT	RS-232	RS-422	LIGHT PEN
INTERFACE FORMAT				
RS-232 (RS-422)	*	✓	✓	
Light Pen				✓
No Comm	Test Mode Only			
CODE TYPES				
All UPC/EAN	*	✓	✓	✓
Code 39	*	✓	✓	✓
Full ASCII Code 39		✓	✓	✓
MOD 43 Check on Code 39		✓	✓	✓
Code 93	*	✓	✓	✓
Code 128	*	✓	✓	✓
Codabar	*	✓	✓	✓
Interleaved 2 of 5 (ITF)	*	✓	✓	✓
MOD 10 Check on ITF		✓	✓	✓
Do Not Scan EAN-8		✓	✓	✓
Do Not Scan EAN-13		✓	✓	✓
Do Not Scan UPC-E		✓	✓	✓
Do Not Scan UPC-A		✓	✓	✓
Paraf		✓	✓	✓
UCC Supplemental Codes		Special firmware required		
2 Digits Supps		✓	✓	✓
5 Digit Supps		✓	✓	✓
977 (2 Digit Supps)		✓	✓	✓
Bookland		✓	✓	✓
Redundancy 2 Digits		✓	✓	✓
Redundancy 5 digits		✓	✓	✓
Require Supps		✓	✓	✓
100 msec to find Supps	*	✓	✓	✓

APPENDIX B (CONTINUED)

PARAMETER	DEFAULT	RS-232	RS-422	LIGHT PEN
200 msec to find Supps		✓	✓	✓
Code 128 Coupon Option		✓	✓	✓
Code 128 Coupon Conversion		✓	✓	✓
378/379 lock on supplement		✓	✓	✓
Remote supplement required		✓	✓	✓
MISCELLANEOUS				
Beep after transmitting		✓	✓	✓
Beep before transmitting	*	✓	✓	✓
Faster Beep/Same Tone		✓	✓	✓
Lost Communication Timeout 3 beeps on timeout razz beep on timeout 5 retrys before timeout		✓	✓	✓
Support 'D/E' disable/enable commands		✓	✓	
Support 'F/L' laser off/on commands		✓	✓	
Enable MECCA		✓	✓	✓
One Compare Buffer	*	✓	✓	✓
Two Compare Buffers		✓	✓	✓
Four Compare Buffers		✓	✓	✓
Eight Compare Buffers		✓	✓	✓
Scan Count		✓	✓	✓
Reverse LED convention		✓	✓	✓
Support multiple beep 'B'/razz 'Z' commands		✓	✓	
Support host BEL/CAN (cancel) command		✓	✓	
Enter program mode only after power up		✓	✓	✓
Enable status reporting		✓	✓	
Number of good scans required (1-8)	1	✓	✓	✓
Special code select		✓	✓	✓
Normal volume	*	✓	✓	✓
Loud Volume		✓	✓	✓
Support 'M/O' motor off/on commands		✓	✓	
TRIAC/LINE SENSOR				
Support Line Sensor		✓	✓	✓
Support Line Sensor Alarm		✓	✓	✓
Transmit 'No Read' message on sensor timeout		✓	✓	✓
Scans per Sensor Activation (1-5)		✓	✓	✓
Scan Duration (sec.)		✓	✓	✓
Support Triac		✓	✓	✓
Triac Controlled by the Host (DC2/DC4)		✓	✓	
Triac Normally On		✓	✓	✓
Enable Read and Match Mode		✓	✓	✓

APPENDIX B (CONTINUED)

PARAMETER	DEFAULT	RS-232	RS-422	LIGHT PEN
Fire triac if good read/match		✓	✓	✓
Fire triac if bad match		✓	✓	✓
Fire triac if no read		✓	✓	✓
Triac Duration (sec.)		✓	✓	✓
Delay Time before firing (sec.)		✓	✓	✓
Enable programmable 'No Read' message		✓	✓	✓
Retain same symbol timers along with line sensor		✓	✓	✓
Supports dual line sensor inputs		✓	✓	✓
Buffer scans until line sensor cycle completes		✓	✓	✓
Save read and match bar code if power down		✓	✓	✓
SCAN RANGE				
Close, Extended and Normal	Extended	✓	✓	✓
RESERVE CODES				
Reserve Code 1-99		✓	✓	✓
RS232 FORMAT				
BAUD				
300-38,400	9600	✓	✓	
DATA FORMAT				
Odd, Space, Even, Mark, None Parity	Space	✓	✓	
7 Data Bits/8 Data Bits	7 Data Bits	✓	✓	
1 Stop bit/2 Stop bits	2 Stop bits	✓	✓	
OPTIONS				
Ack/Nak handshaking		✓	✓	
CR	*	✓	✓	
LF	*	✓	✓	
DTR support		✓	✓	
Nixdorf ID		✓	✓	
RTS/CTS handshaking		✓	✓	
RTS/CTS (character)		✓	✓	
RTS/CTS (message)		✓	✓	
ETX suffix		✓	✓	
STX prefix		✓	✓	
Tab prefix		✓	✓	
Tab suffix		✓	✓	
UPC prefix		✓	✓	
UPC suffix		✓	✓	
Schlumberger/Shell format		✓	✓	
Transmit AIM ID Chr		✓	✓	

APPENDIX B (CONTINUED)

PARAMETER	DEFAULT	RS-232	RS-422	LIGHT PEN
Transmit SANYO ID Chr		✓	✓	
SNI Beetle Mode		✓	✓	
French PC Term	not currently supported	✓	✓	
Xon/Xoff handshaking		✓	✓	
Programmable prefix identifiers		✓	✓	
Xmit (dec) as 1st prefix identifier				
Xmit (dec) as 2nd prefix identifier				
Programmable suffix identifiers		✓	✓	
Xmit (dec) as 1st suffix identifier				
Xmit (dec) as 2nd suffix identifier				
LIGHT PEN FORMAT				
POLL SRC				
No/Yes	No			✓
HI/OUTPUT				
Bars/Code 39, Spaces/Code 39, Spaces/Code 39, Bars/as scanned, Spaces/as scanned	Spaces/as scanned			✓
OPTIONS				
Extra Transition before Bar Code				✓
50x element border				✓
10x narrow element border				✓
1.0 ms narrow element	*			✓
.50 ms narrow element				✓
.30 ms narrow element				✓
.15 ms narrow element				✓
FORMATTING - UPC				
Convert EAN-8 to EAN-13		✓	✓	
Convert UPC-A to EAN-13		✓	✓	
Expand UPC-E		✓	✓	
Transmit lead zero on UPC-E		✓	✓	
Transmit UPC-A check digit	*	✓	✓	
Transmit UPC-A Number System	*	✓	✓	
Transmit UPC-E check digit		✓	✓	
Transmit EAN-13 check digit	*	✓	✓	
Transmit EAN-8 check digit	*	✓	✓	
FORMATTING - NONUPC				
CLSI editing		✓	✓	
Transmit Codabar Start/Stop Characters		✓	✓	

APPENDIX B (CONTINUED)

PARAMETER	DEFAULT	RS-232	RS-422	LIGHT PEN
Transmit Code 39 Start/Stop Characters		✓	✓	
Transmit ITF Mod 10 check digit		✓	✓	
Transmit Code 39 Mod 43 check digit		✓	✓	
SYMBOL LENGTH				
ITF(variable length-50 char)	14 char lock	✓	✓	✓
Min 1-50	4	✓	✓	✓
Lock 0-50	0	✓	✓	✓
BEEPER TONE				
Normal, Alt1, Alt 2, Alt3, Alt4, None	Normal	✓	✓	✓
LED				
Flash/None	Flash	✓	✓	✓
Same Symbol Time Out				
.1, .2, .5, 1.25, 2.00secs, infinite	.5 secs	✓	✓	✓
TRANSMISSION DELAY - Inter character				
1,5,20 msec, none	1 msec.	✓	✓	

APPENDIX C

IS8000 Series Pinout Connections

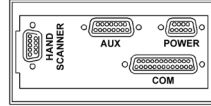

IS8400/IS8500/IS8800

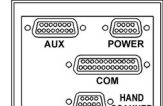

IS8300

DESCRIPTION	PIN	SIGNAL
Connector Type on Scanner DB25P (D-Type 25 Pin Male) 	1	Ground
	2	RS-232 Receive Input
	3	RS-232 Transmit Output
	4	CTS Input
	5	RTS Output
	6	Reserved
	7	Ground
	8	Reserved
	9	RS-422 Receive - (B-)
	10	RS-422 Receive + (A+)
Function: Communication Pinouts for RS-232/RS-422 and Light Pen Emulation.	11	RS-422 Send + (Y+)
	12	RS-422 Send - (Z-)
	13	Ground
	14	Ground
	15	Light Pen Source
	16	Light Pen Data
	17	Reserved
	18	Reserved
	19	Open
	20	DTR Input
RS-232 Cable Note: Cables for RS-232 should leave the RS-422 pins unterminated at the scanner. RS-422 Cable Note: Cables for RS-422 should leave the RS-422 transmit and receive pins unterminated at the scanner.	21	Reserved
	22	Reserved
	23	Reserved
	24	Reserved
	25	Ground

DESCRIPTION	PIN	SIGNAL
Connector Type on Scanner: DA15P (D-Type 15-Pin Male) 	1	RS-232 Receive Data (Input)
	2	Clear to Send (Output)
	3	Reserved
	4	Reserved
	5	Triac +
	6	Sensor +
	7	Sensor Alarm +
	8	Reserved
	9	RS-232 Transmit Data (Output)
	10	Request to Send (Input)
Function: Auxiliary RS-234 industrial Interface Port	11	Signal Ground
	12	Reserved
	13	Triac -
	14	Sensor -
	15	Sensor Alarm -

APPENDIX C

IS8000 Series Pinout Connections

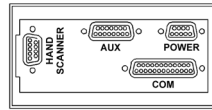

IS8400/IS8500/IS8800

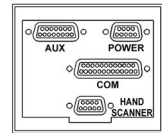

IS8300

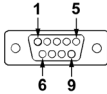
DESCRIPTION	PIN	SIGNAL
Connector Type on Scanner: DEC9P (D-Type 9-Pin Male) 	1	12VDC Input Power to Scanner
	2	12VDC Input Power to Scanner
	3	Earth Ground
	5	Power Ground
	4	Power Ground
	6	12VDC Input Power to Scanner
Function: Power Port	7	12VDC Input Power to Scanner
	8	Power Ground
	9	Power Ground

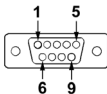
DESCRIPTION	PIN	SIGNAL
Connector Type on Scanner: DEC9P (D-Type 9 Pin Male) 	1	Flip Sense
	2	Data
	3	Decode LED
	4	Reserved
	5	Proximity Detect
	6	Laser/Motor Control
Function: Hand Held Port (Low Speed Option)	7	Ground
	8	Shield
	9	+5VDC Power to Scanner

IS8400E/IS8400LE and IS8500E/IS8500LE Scanners Only

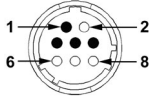
DESCRIPTION	PIN	SIGNAL
Connector Type on Scanner 8 Pin AMP CPC Male 	1	Beeper Signal
	2	N/C
	3	Red LED
	4	Power Ground
	5	Green LED
Function: External Speaker Box Port	6	N/C
	7	N/C
	8	N/C

APPENDIX D

Limited Warranty

The IS8000 series scanners are manufactured by Metrologic at its Blackwood, New Jersey, U.S.A. facility. The IS8000 series scanners have a three (3) year limited warranty from the date of manufacture. Metrologic warrants and represents that all IS8000 series scanners are free of all defects in material, workmanship and design, and have been produced and labeled in compliance with all applicable U.S. Federal, state and local laws, regulations and ordinances pertaining to their production and labeling.

This warranty is limited to repair, replacement of Product or refund of Product price at the sole discretion of Metrologic. Faulty equipment must be returned to the Metrologic facility in Blackwood, New Jersey, U.S.A. or Puchheim, Germany. To do this, contact Metrologic's Customer Service/Repair Department to obtain a Returned Material Authorization (RMA) number.

In the event that it is determined the equipment failure is covered under this warranty, Metrologic shall, at its sole option, repair the Product or replace the Product with a functionally equivalent unit and return such repaired or replaced Product without charge for service or return freight, whether distributor, dealer/reseller, or retail consumer, or refund an amount equal to the original purchase price.

This limited warranty does not extend to any Product which, in the sole judgement of Metrologic, has been subjected to abuse, misuse, neglect, improper installation, or accident, nor any damage due to use or misuse produced from integration of the Product into any mechanical, electrical or computer system. The warranty is void if the case of Product is opened by anyone other than Metrologic's repair department or authorized repair centers.

THIS LIMITED WARRANTY, EXCEPT AS TO TITLE, IS IN LIEU OF ALL OTHER WARRANTIES OR GUARANTEES, EITHER EXPRESS OR IMPLIED, AND SPECIFICALLY EXCLUDES, WITHOUT LIMITATION, WARRANTIES OF MERCHANTABILITY AND FITNESS FOR A PARTICULAR PURPOSE UNDER THE UNIFORM COMMERCIAL CODE, OR ARISING OUT OF CUSTOM OR CONDUCT. THE RIGHTS AND REMEDIES PROVIDED HEREIN ARE EXCLUSIVE AND IN LIEU OF ANY OTHER RIGHTS OR REMEDIES. IN NO EVENT SHALL METROLOGIC BE LIABLE FOR ANY INDIRECT OR CONSEQUENTIAL DAMAGES, INCIDENTAL DAMAGES, DAMAGES TO PERSON OR PROPERTY, OR EFFECT ON BUSINESS OR PROPERTY, OR OTHER DAMAGES OR EXPENSES DUE DIRECTLY OR INDIRECTLY TO THE PRODUCT, EXCEPT AS STATED IN THIS WARRANTY. IN NO EVENT SHALL ANY LIABILITY OF METROLOGIC EXCEED THE ACTUAL AMOUNT PAID TO METROLOGIC FOR THE PRODUCT. METROLOGIC RESERVES THE RIGHT TO MAKE ANY CHANGES TO THE PRODUCT DESCRIBED HEREIN.

Corporate Headquarters

Metrologic Instruments, Inc.
90 Coles Road
Blackwood, NJ 08012-4683

Customer Service: 1-800-ID-METRO
Tel: 856-228-8100
Fax: 856-228-6673
Email: info@metrologic.com
Website: www.metrologic.com

Germany

Metrologic Instruments GmbH
Dornierstrasse 2
82178 Puchheim b.
Munich, Germany

Tel: 49-89-89019-0
Fax: 49-89-89019-200
Email: info@europe.metrologic.com

APPENDIX E

Notices

This equipment has been tested and found to comply with limits for a Class A digital device, pursuant to Part 15 of the FCC Rules. These limits are designed to provide reasonable protection against harmful interference when the equipment is operated in a commercial environment. This equipment generates, uses and can radiate radio frequency energy and, if not installed and used in accordance with the instruction manual, may cause harmful interference to radio communications. Operation of this equipment in a residential area is likely to cause harmful interference, in which case the user will be required to correct the interference at his own expense. Any unauthorized changes or modifications to this equipment could void the users authority to operate this device.

This device complies with Part 15 of the FCC Rules. Operation is subject to the following two conditions: (1) This device may not cause harmful interference, and (2) this device must accept any interference received, including interference that may cause undesired operation.

Notice

This Class A digital apparatus complies with Canadian ICES-003.

Remarque

Cet appareil numérique de la classe A conforme a la norme NMB-003 du Canada.

Caution

Use of controls or adjustments or performance of procedures other than those specified herein may result in hazardous laser light exposure. Under no circumstances should the customer attempt to service the laser scanner. Never attempt to look at the laser beam, even if the scanner appears to be nonfunctional. Never open the scanner in an attempt to look into the device. Doing so could result in hazardous laser light exposure. The use of optical instruments with the laser equipment will increase eye hazard.

Atención

La modificación de los procedimientos, o la utilización de controles o ajustes distintos de los especificados aquí, pueden provocar una luz de láser peligrosa. Bajo ninguna circunstancia el usuario deberá realizar el mantenimiento del láser del escáner. Ni intentar mirar al haz del láser incluso cuando este no esté operativo. Tampoco deberá abrir el escáner para examinar el aparato. El hacerlo puede conllevar una exposición peligrosa a la luz de láser. El uso de instrumentos ópticos con el equipo láser puede incrementar el riesgo para la vista.

Attention

L'emploi de commandes, réglages ou procédés autres que ceux décrits ici peut entraîner de graves irradiations. Le client ne doit en aucun cas essayer d'entretenir lui-même le scanner ou le laser. Ne regardez jamais directement le rayon laser, même si vous croyez que le scanner est inactif. N'ouvrez jamais le scanner pour regarder dans l'appareil. Ce faisant, vous vous exposez à une rayonnement laser qu'est dangereux. L'emploi d'appareils optiques avec cet équipement laser augmente le risque d'endommagement de la vision.

APPENDIX E (CONTINUED)

Achtung

Die Verwendung anderer als der hier beschriebenen Steuerungen, Einstellungen oder Verfahren kann eine gefährliche Laserstrahlung hervorrufen. Der Kunde sollte unter keinen Umständen versuchen, den Laser-Scanner selbst zu warten. Sehen Sie niemals in den Laserstrahl, selbst wenn Sie glauben, daß der Scanner nicht aktiv ist. Öffnen Sie niemals den Scanner, um in das Gerät hineinzusehen. Wenn Sie dies tun, können Sie sich einer gefährlichen Laserstrahlung aussetzen. Der Einsatz optischer Geräte mit dieser Laserausrüstung erhöht das Risiko einer Sehschädigung.

Attenzione

L'utilizzo di sistemi di controllo, di regolazioni o di procedimenti diversi da quelli descritti nel presente Manuale può provocare delle esposizioni a raggi laser rischiose. Il cliente non deve assolutamente tentare di riparare egli stesso lo scanner laser. Non guardate mai il raggio laser, anche se credete che lo scanner non sia attivo. Non aprite mai lo scanner per guardare dentro l'apparecchio. Facendolo potete esporVi ad una esposizione laser rischiosa. L'uso di apparecchi ottici, equipaggiati con raggi laser, aumenta il rischio di danni alla vista.

European Standard

Warning

This is a class A product. In a domestic environment this product may cause radio interference in which case the user may be required to take adequate measures.

Funkstöreigenschaften nach EN 55022:1998

Warnung!

Dies ist eine Einrichtung der Klasse A. Diese Einrichtung kann im Wohnbereich Funkstörungen verursachen; in diesem fall kann vom Betreiber verlangt werden, angemessene Maßnahmen durchführen.

Standard Europeo

Attenzione

Questo e' un prodotto di classe A. Se usato in vicinanza di residenze private potrebbe causare interferenze radio che potrebbero richiedere all'utilizzatore opportune misure.

Attention

Ce produit est de classe "A". Dans un environnement domestique, ce produit peut être la cause d'interférences radio. Dans ce cas l'utiliseteur peut être amené à predre les mesures adéquates

APPENDIX F

Patents

"Patent Information

This METROLOGIC product may be covered by one or more of the following U.S. Patents:

U.S. Patent No.; 5,081,342; 5,260,553; 5,343,027; 5,686,717; 5,777,315; 5,828,049; 5,975,419; 5,984,185; 6,003,772; 6,006,993; 6,024,282; 6,062,479; 6,073,846; 6,076,736; 6,085,978; 6,085,980; 6,112,990; 6,185,659; 6,182,897; 6,199,759; 6,290,132; 6,328,215; 6,347,743; 6,360,947; 6,375,074; 6,415,980; 6,422,466; 6,439,462; 6,457,642; 6,457,646; 6,464,141; 6,474,556;

4,360,798; 4,369,361; 4,387,297; 4,460,120; 4,496,831; 4,593,186; 4,607,156; 4,673,805; 4,736,095; 4,758,717; 4,816,660; 4,845,350; 4,896,026; 4,923,281; 4,933,538; 4,992,717; 5,015,833; 5,017,765; 5,059,779; 5,117,098; 5,124,539; 5,130,520; 5,132,525; 5,140,144; 5,149,950; 5,180,904; 5,200,599; 5,229,591; 5,247,162; 5,250,790; 5,250,791; 5,250,792; 5,262,628; 5,280,162; 5,280,164; 5,304,788; 5,321,246; 5,324,924; 5,396,053; 5,396,055; 5,408,081; 5,410,139; 5,436,440; 5,449,891; 5,468,949; 5,479,000; 5,532,469; 5,545,889

No license right or sublicense is granted, either expressly or by implication, estoppel, or otherwise, under any METROLOGIC or third party intellectual property rights (whether or not such third party rights are licensed to METROLOGIC), including any third party patent listed above, except for an implied license only for the normal intended use of the specific equipment, circuits, and devices represented by or contained in the METROLOGIC products that are physically transferred to the user, and only to the extent of METROLOGIC's license rights and subject to any conditions, covenants and restrictions therein."

Other worldwide patents pending.

INDEX

A

ac input/outlet3-7, 9, 21, 28
accessories2
approvals.....4, 13, 20, 21, 30, 31
assignments
 pin 10, 27, 28
audible6, 10, 12

B

bar code 1, 5, 10, 12, 18, 24
bar width.....21
beep 6, 7, 10, 12, 23, 28

C

cable.....2, 3, 4, 5, 7, 8
 communication..... 10, 19, 27
 pin assignments 10, 27, 28
caution..... 3, 4, 5, 6, 7, 30
cdrh 13, 21
communication 1, 22, 23, 27, 30
compliance 3, 4, 6, 7, 9, 29
configuration procedures 1, 2, 5,
 8-10, 19
customer service ii, 29, 30

D

dc transformer2, 9
decode capability.....28
default settings 8, 22, 26
depth of field.... 1, 14, 15, 16, 17, 21
design specifications20, 21

E

electrical power supply2-7, 19

F

failure indicator(s)..... 12, 19

H

host..... 3, 4, 5, 6, 7, 8, 9, 12, 19, 23

I

indicators..... 10, 12
input voltage..... 2-4, 21, 24, 27, 28
installation 3, 5, 8, 11, 29
interfaces 1, 10, 19, 21, 22, 27

L

light pen 1, 21, 22, 26, 27
light source..... 3, 4, 6, 9, 27

M

maintenance 18, 19

N

notices..... 30

O

operating current 21
operating temperature..... 21

P

parts 2, 10
pin assignments 10, 27, 28
port..... 1, 5, 7, 9, 10, 19, 21
power supply..... 3-7, 10, 19, 21
programming..... 5, 8, 12

R

razzberry tone 12, 19
repair..... 29
RMA..... 29
RS-232..... 1, 9, 21, 22, 26, 27

S

scan pattern 14-17, 19, 21
SELV..... 3, 6, 7, 9
service.....ii, 19, 29, 30

INDEX

specifications.....20, 21

system interfaces 1, 8, 20, 22

T

tones.....6

transformers9

troubleshooting..... 19

V

ventilation..... 21

visual..... 10, 12

voltage 21

W

warranty 29

weight 21

window 2, 10, 18, 19

January 2004

Printed in the USA



00 - 02377